



UNIVERSITY OF CAMBRIDGE INTERNATIONAL EXAMINATIONS
International General Certificate of Secondary Education

CANDIDATE
NAME

CENTRE
NUMBER

--	--	--	--	--

CANDIDATE
NUMBER

--	--	--	--



PHYSICS

0625/06

Paper 6 Alternative to Practical

October/November 2007

1 hour

Candidates answer on the Question Paper.
No Additional Materials are required.

Write your Centre number, candidate number and name on all work you hand in.
Write in dark blue or black pen.
You may use a soft pencil for any diagrams, graphs or rough working.
Do not use staples, paper clips, highlighters, glue or correction fluid.
DO NOT WRITE IN ANY BARCODES.

Answer **all** questions.

At the end of the examination, fasten all your work securely together.
The number of marks is given in brackets [] at the end of each question or part question.

For Examiner's Use	
1	
2	
3	
4	
5	
Total	

This document consists of **11** printed pages and **1** blank page.



1 The IGCSE class is investigating the rate of cooling of hot water.

- (a) A student measures room temperature. Write down the value of room temperature shown on the thermometer in Fig. 1.1.

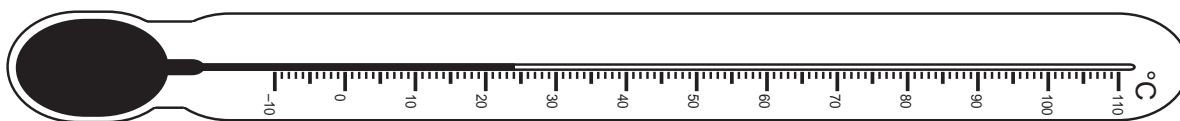

Fig. 1.1

$$\theta_0 = \dots\dots\dots [1]$$

- (b) He then pours hot water into a beaker until it is about two-thirds full. He measures and records the temperature θ of the hot water and at the same time starts a stopwatch. As the water cools, he records the temperature every 30 s for a total of five minutes. His readings are shown in the table below.

$t/$	$\theta/$
0	68.0
30	53.0
60	45.0
90	40.0
120	36.5
150	33.5
180	32.0
210	30.0
240	29.0
270	28.5
300	28.0

- (i) Complete the column headings in the table.
- (ii) Calculate the temperature fall T_1 in the first minute of the experiment.

$$T_1 = \dots\dots\dots$$

- (iii) Calculate the temperature fall T_2 in the final minute of the experiment.

$$T_2 = \dots\dots\dots$$

[3]

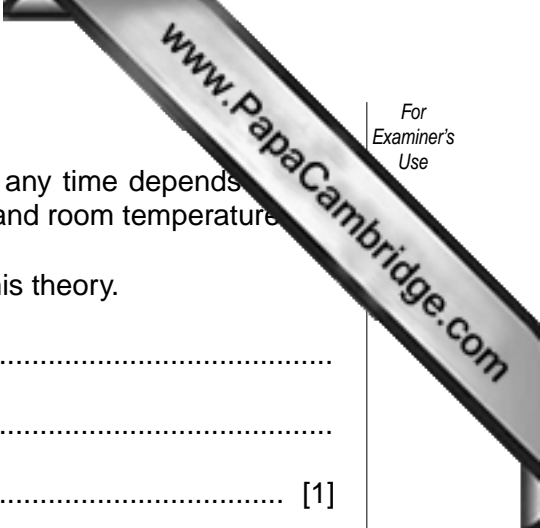

(c) Theory suggests that the rate of cooling of the hot water at any time depends on the difference between the temperature of the water at that time and room temperature.

(i) State and explain whether your answers in (b) support this theory.

Statement

Explanation

..... [1]

(ii) Suggest three variables that you would attempt to keep constant if this theory were to be investigated further.

1.

2.

3. [3]

(d) Suggest one addition you could make to the apparatus provided in order to reduce the rate of evaporation of the water in the beaker.

..... [1]

[Total: 9]

2 The IGCSE class is investigating a simple balance.

The diagram below shows the apparatus.

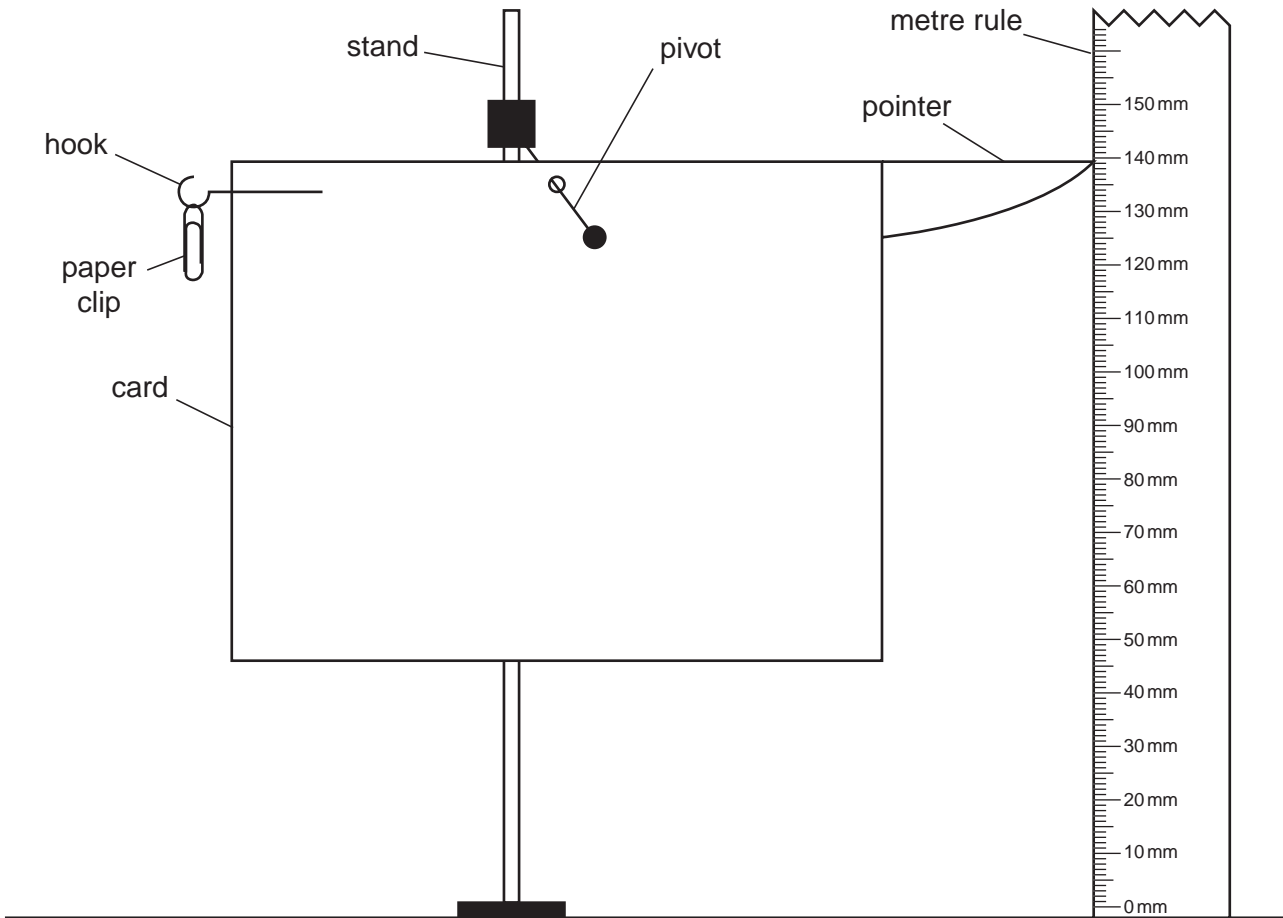

Fig. 2.1

- (a) A student records the height h_0 of the pointer above the bench. She then hangs a paper clip on the hook and records the new height h of the pointer above the bench. Next she records the heights of the pointer above the bench using different numbers N of paper clips. The readings are shown in the table below.

$$h_0 = 100 \text{ mm}$$

N	h/mm	d/mm
1	108	
2	114	
3	120	
4	125	
5	134	
6	141	

Calculate the height differences d using the equation

$$d = (h - h_0)$$

and enter them in the table.

[2]

- (b) (i) Plot the graph of d/mm (y -axis) against N (x -axis).

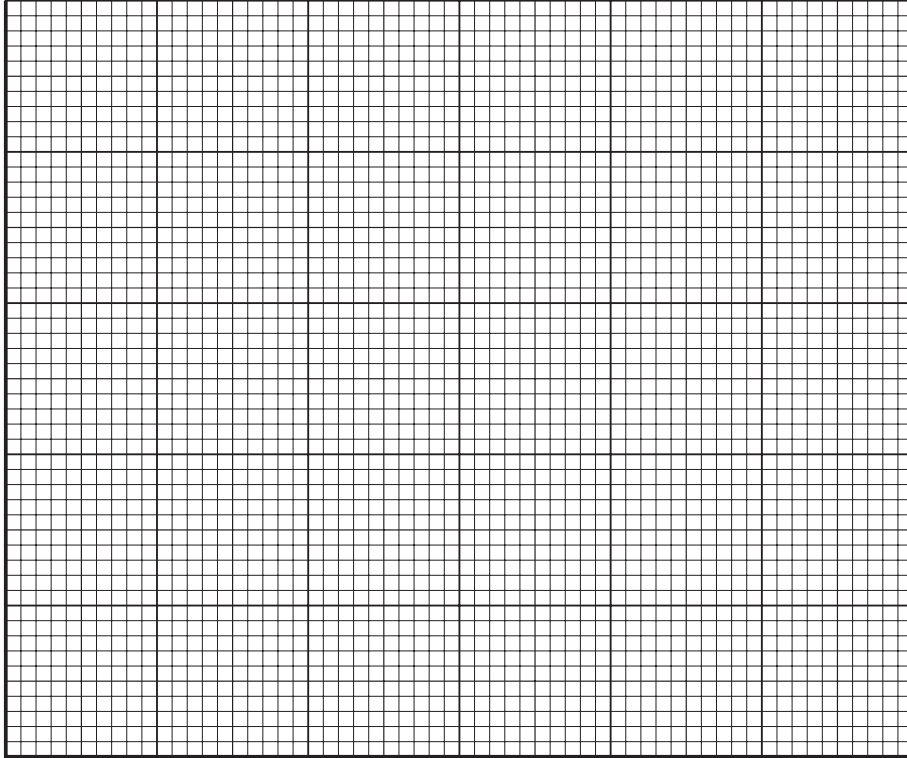

- (ii) Use your graph to predict the value of d if a nail with the same mass as 4.6 paper clips were to be hung from the hook in place of the paper clips. Show clearly on the graph how you obtained your value.

$d = \dots\dots\dots$ [6]

[Total: 8]

- 3 The IGCSE class is investigating the potential difference across lamps and the current through the lamps.

Fig. 3.1 shows the circuit that is being used.

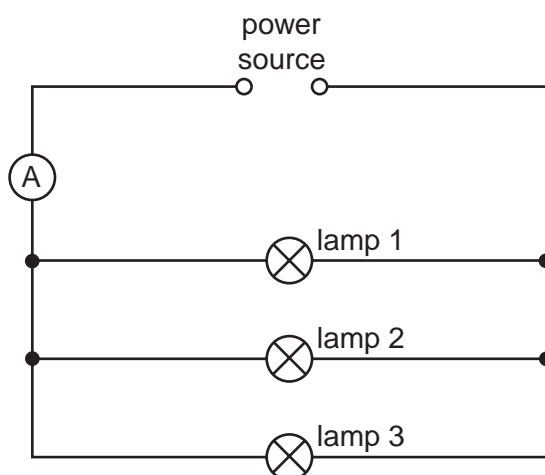
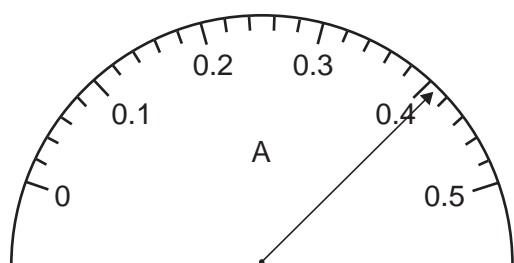

Fig. 3.1

- (a) A student uses the ammeter to record the current I in the wire connecting the power source to the rest of the circuit. He then moves the ammeter to new positions in the circuit and measures the current in each lamp in turn. The positions of the pointer on the ammeter scale are shown below.

(i)



current $I = \dots\dots\dots$

(ii)

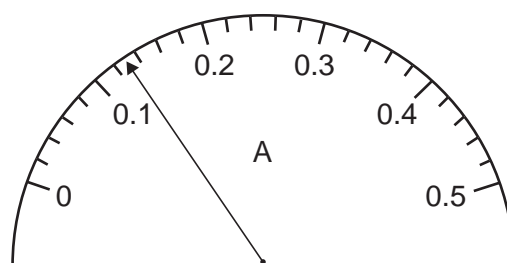

current I_1 in lamp 1 = $\dots\dots\dots$

(iii)

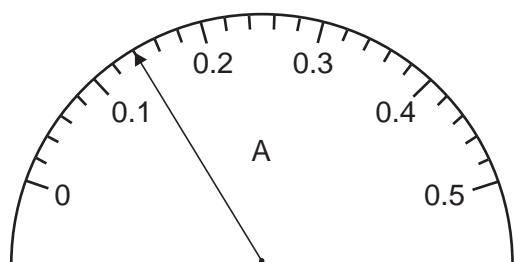

current I_2 in lamp 2 = $\dots\dots\dots$

(iv)

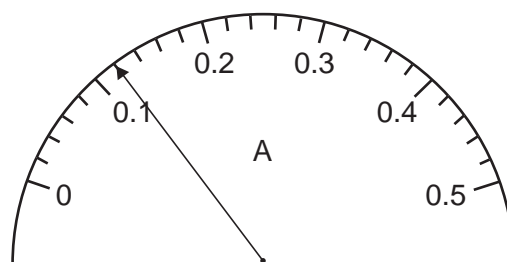

current I_3 in lamp 3 = $\dots\dots\dots$

Write down the ammeter readings I , I_1 , I_2 and I_3 .

- (b) Theory suggests that $I = I_1 + I_2 + I_3$. State whether or not your readings support the theory. Give a reason for your answer.

Statement

Reason

.....

..... [1]

- (c) To test the theory further, you would need to vary the value of I . State how you would vary I .

.....

..... [1]

- (d) The student uses a voltmeter to measure the potential difference V across the lamps.

His reading is $V = 1.6V$.

- (i) Calculate the resistance R of the lamps arranged in parallel, using the equation

$$R = V/I,$$

where I is the value of the current in (a)(i).

$R =$

- (ii) On Fig. 3.1, add the symbol for the voltmeter connected to measure the potential difference across the lamps. [3]

[Total: 8]

- 4 The IGCSE class is investigating the refraction of light through a transparent block.

Fig. 4.1 shows the apparatus used.

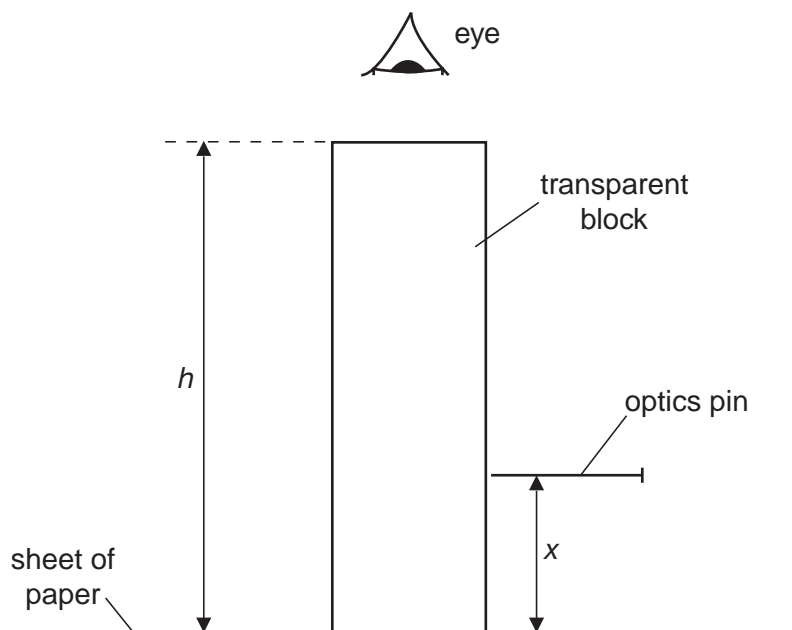

Fig. 4.1

- (a) A student looks down through the transparent block at the image of a line drawn on the sheet of paper. She carefully places the point of the optics pin exactly in line with the image.

- (i) On Fig. 4.1, measure the vertical distance x between the paper and the pin.

$x =$

- (ii) On Fig. 4.1, measure the height h of the transparent block.

$h =$

- (iii) Calculate the refractive index n of the material of the block using the equation

$$n = \frac{h}{h-x}.$$

$n =$ [5]

- (b) To obtain a reliable value for the vertical distance x between the paper and the pin, it is important that the pin is horizontal. Explain briefly with the aid of a diagram how you would check that the pin is horizontal.

.....

..... [1]

[Total: 6]

- 5 (a) An IGCSE student is investigating the differences in density of small pieces of different rocks. She is using an electronic balance to measure the mass of each sample and using the 'displacement method' to determine the volume of each sample. Fig. 5.1 shows the displacement method.

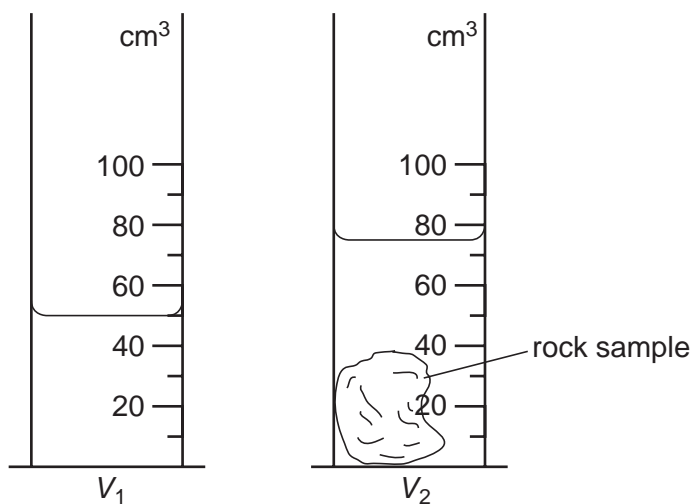

Fig. 5.1

- (i) Write down the volume shown in each measuring cylinder.

$V_1 = \dots\dots\dots$

$V_2 = \dots\dots\dots$

- (ii) Calculate the volume V of the rock sample.

$V = \dots\dots\dots$

- (iii) Calculate the density of sample **A** using the equation

$$density = \frac{m}{V},$$

where the mass m of the sample of rock is 109g.

density = $\dots\dots\dots$

(b) The table shows the readings that the student obtains for samples of rocks B and C. Complete the table by

- (i) inserting the appropriate column headings with units,
 (ii) calculating the densities using the equation $density = \frac{m}{V}$.

sample	m/g			$V/$	density/
B	193	84	50	34	
C	130	93	50	43	

[4]

(c) Explain briefly how you would determine the density of sand grains.

.....
 [1]

[Total: 9]

